

Uspa

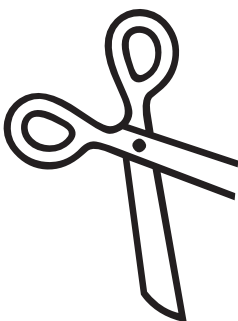

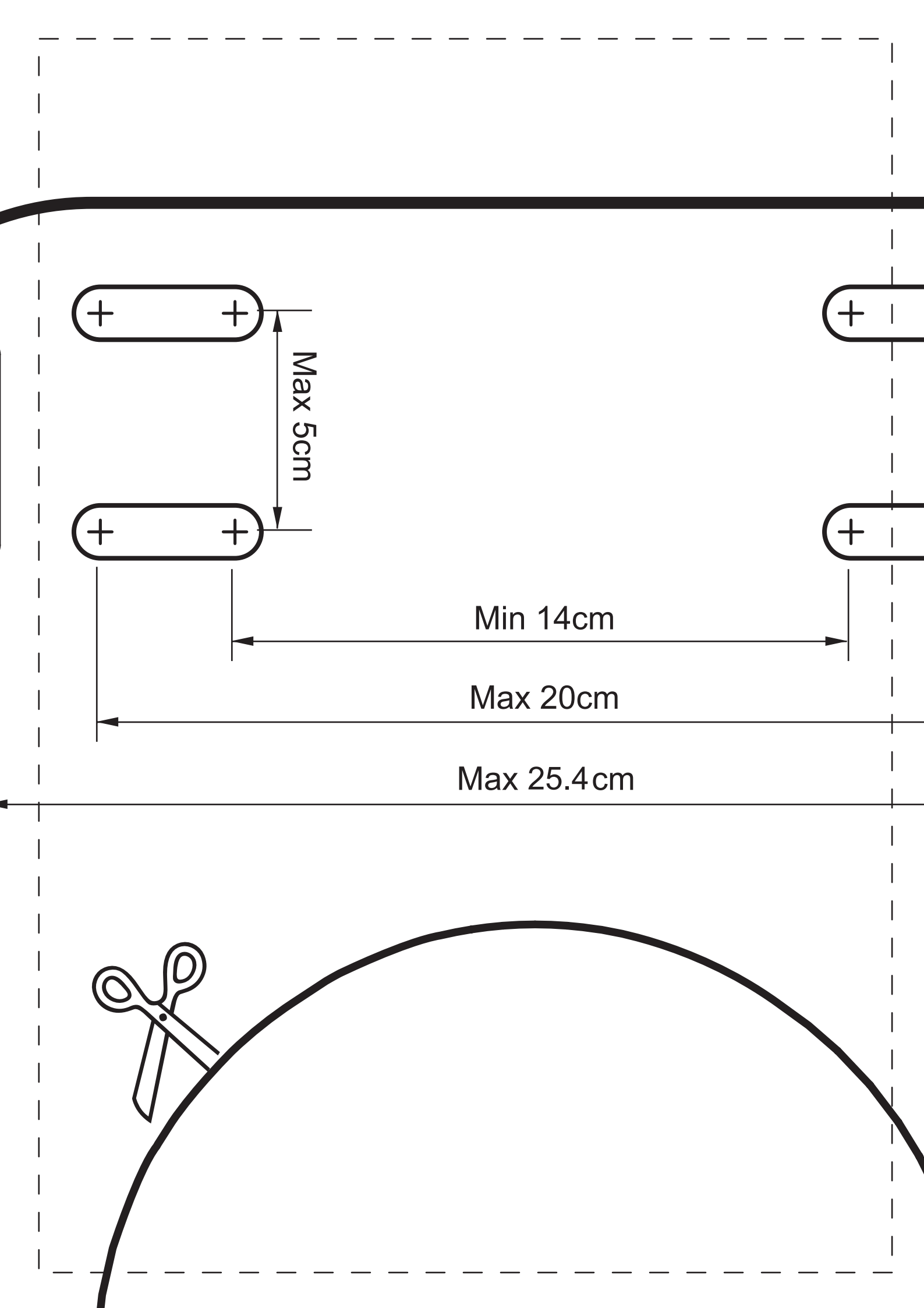

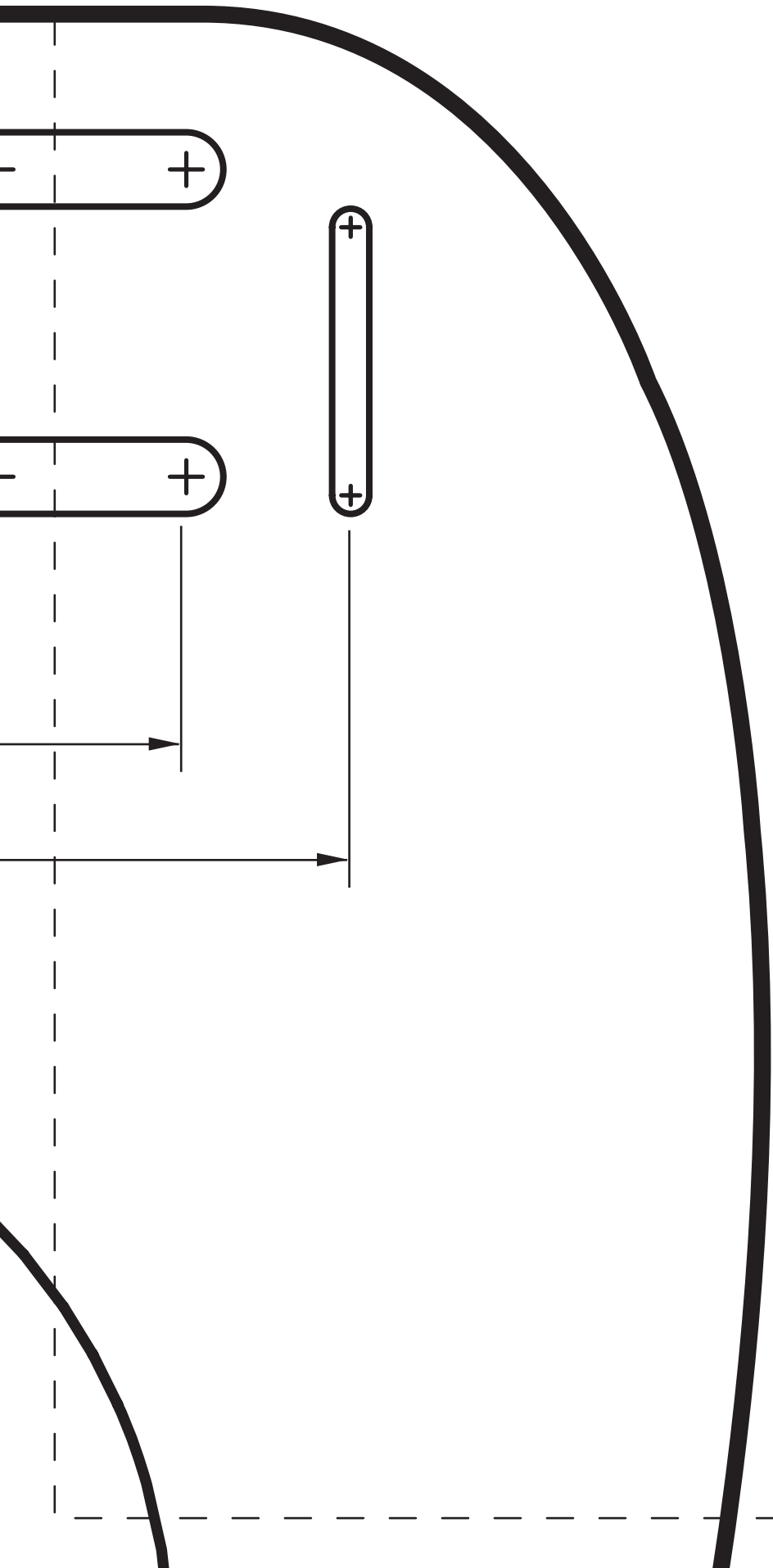

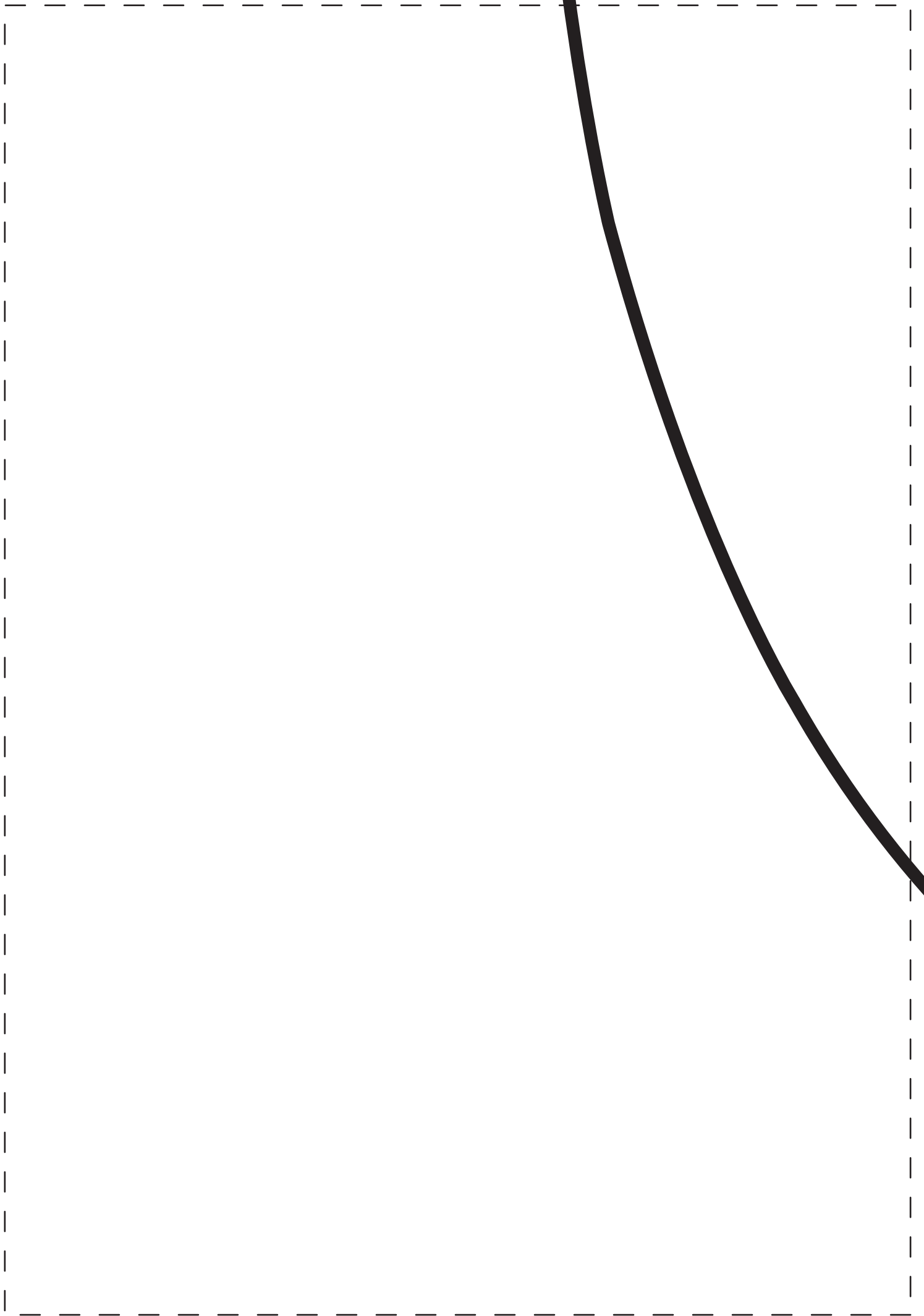

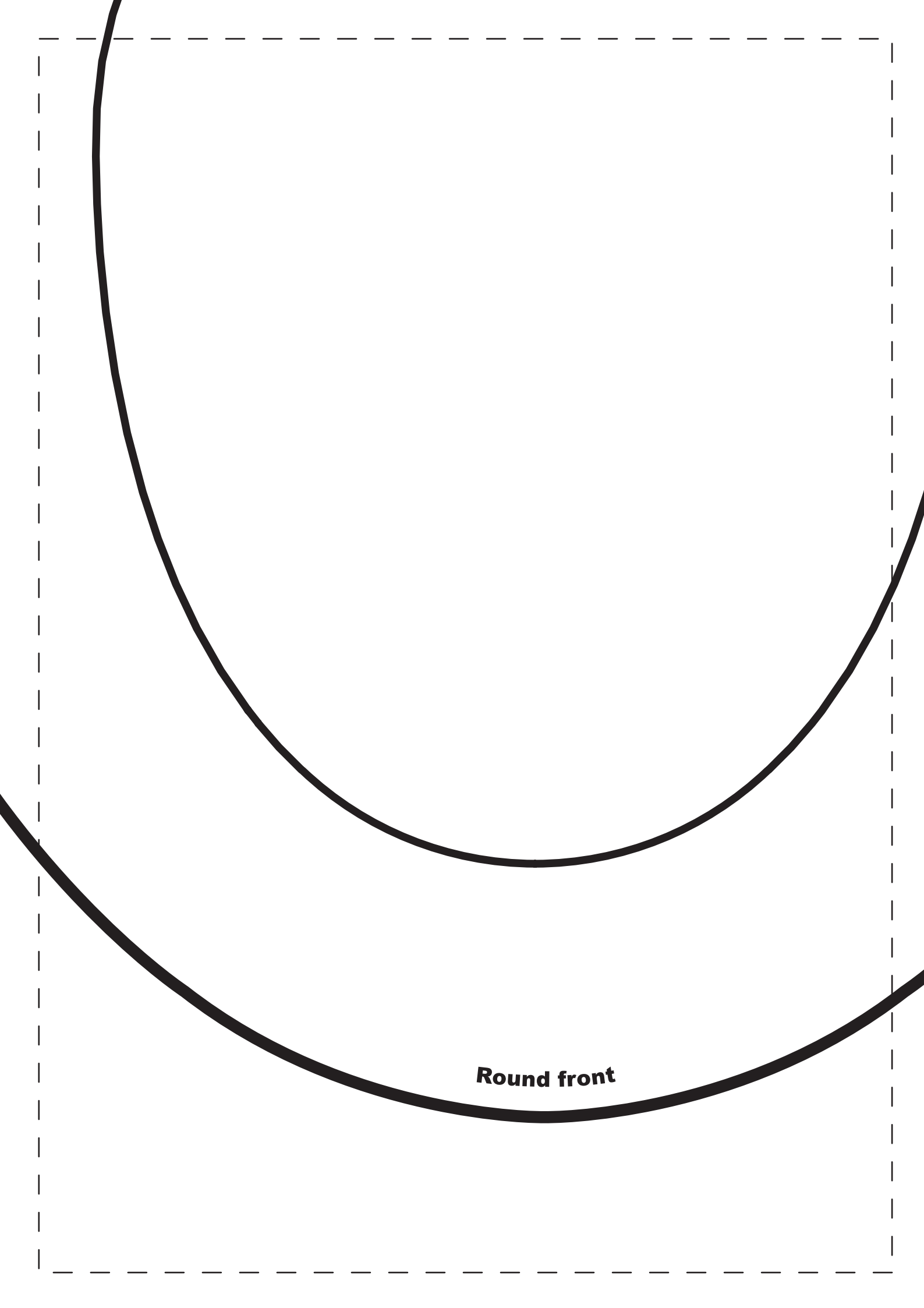

**Round front**

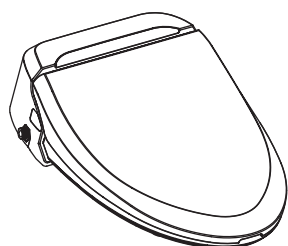
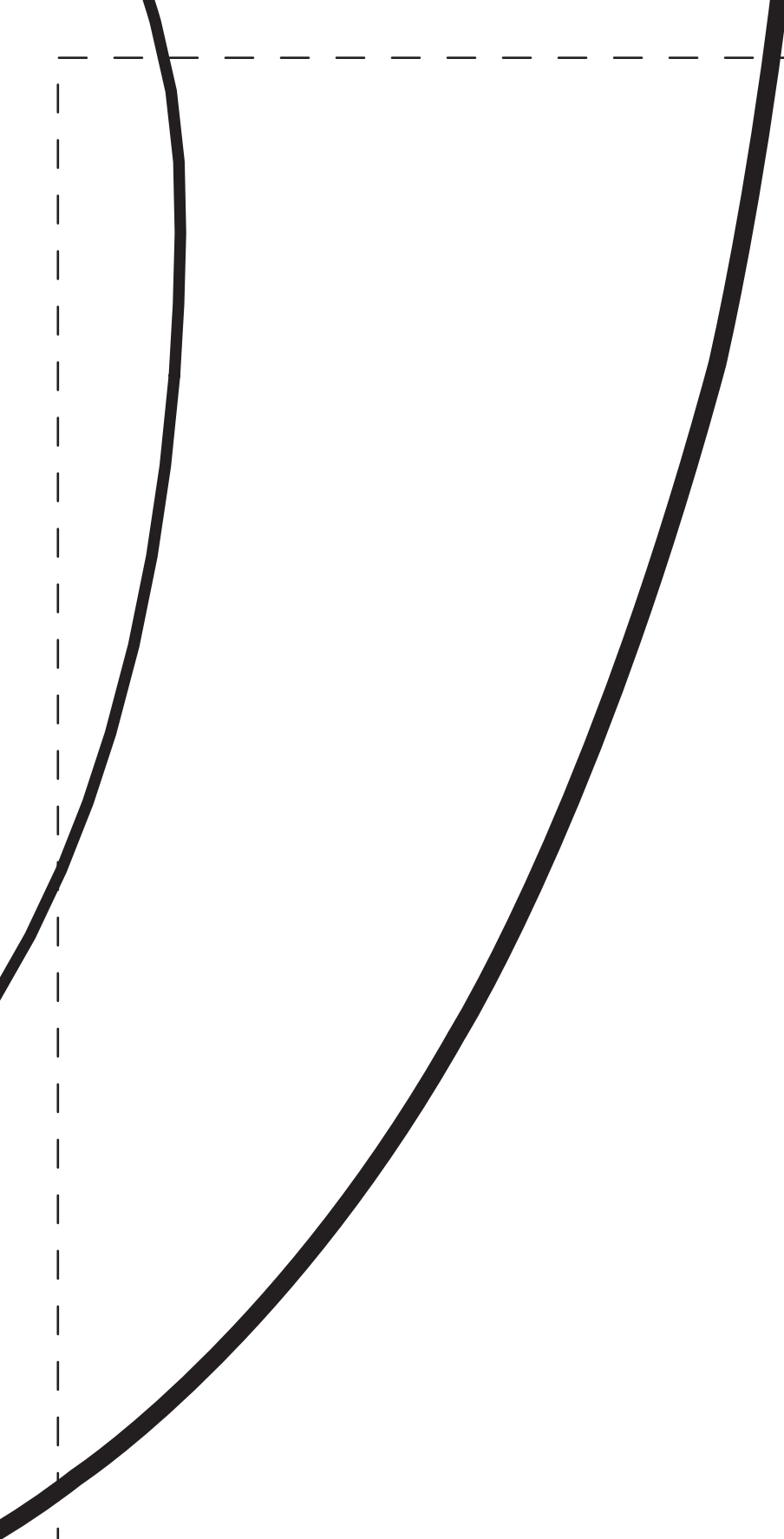

UB-6035RS / UB-6135RS

SCALE 1:1

